

Drum Sander
Operating Instructions



Producer:

Laguna Tools Inc
744 Refuge Way, Suite 200
Grand Prairie, Texas 75050
USA
Phone: +1 800-234-1976
Website: www.lagunatools.com

Distributor:

IGM nástroje a stroje s.r.o.
Ke Kopanině 560, 252 67, Tuchoměřice
Czech Republic, EU
Phone: +420 220 950 910
E-mail: sales@igmttools.com
Website: www.igmttools.com



EC DECLARATION OF CONFORMITY

We
(Manufacturer)

Laguna Tools Inc.
2072 Alton Parkway, Irvine, California 92606, USA

Declare that the product name: Woodworking Drum Sander

Model Name : 71632, 71938, 71938-D, 72550

Conform with the essential safety requirements of the relevant European Directive:

- Machinery Directive 2006/42/EC
- Electromagnetic Compatibility Directive 2014/30/EU

The person who compile technical file established within the EU:

Name: IGM nastroje a stroje s.r.o.
Address: Ke Kopanine 560, Tuchomerice , CZ-252 67
Tel.: +420 220 950 910
Email: sales@igmtools.com

Mounting and connecting instructions defined in catalogues and technical construction files must be respected by the user.

They are based on the following standards :

- EN ISO 12100:2010 Safety of Machinery - General principles for design / Risk Assessment and Risk reduction.
- EN 60204-1:2006+AC:2010 Safety of machinery – Electrical equipment of machines, part 1 : General requirements.
- EN 13849-1:2015 Safety of machinery – Safety – related parts of control systems Part 1: General principles for design
- EN 50370 -1:2005 Electromagnetic compatibility (EMC) – Product family standard for machine tools – Part 1: Emission.
- EN 50370 -2:2003 Electromagnetic compatibility (EMC) – Product family standard for machine tools – Part 2: Immunity.
- EN 61000-4-2: 2009 Electrostatic (ESD)
- EN 61000-4-4: 2012 Electrical fast transient/burst requirements (EFT/Burst)
- EN 61000-4-6: 2014 Immunity to conducted disturbances, induced by radio-frequency fields (CS)

Responsible for the documentation: Head Product Management, Laguna Tools Inc.

Name : Torben Helshoj

Responsibility : President

Authorized Signature

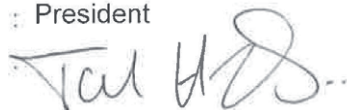

Date : Oct. 15, 2021

Place : Laguna Tools Inc.

2072 Alton Parkway, Irvine, California 92606, USA

Telephone: +1 800 234-1976

Fax: +1 949 474-0150



EN - English

Operating Instructions (Original)

Dear Customer,

many thanks for the confidence you have shown in us with the purchase of your new Laguna Tools machine. This manual has been prepared for the owner and operators of an **IGM LAGUNA 1632 SuperMax Drum Sander** to promote safety during installation, operation and maintenance procedures. Please read and understand the information contained in these operating instructions and the accompanying documents. To obtain maximum life and efficiency from your machine, and to use the machine safely, read this manual thoroughly and follow instructions carefully.

We wish you many work and personal pleasures when working with the Laguna Tools machine.

Table of Contents

1. Declaration of Conformity

2. Warranty

3. Safety

Authorized Use
General Safety Notes
Hazards
Grounding Instructions

4. Machine Specification

5. Transport and Setup

Setup

6. Setting and Adjustment

Drum Sander Adjustment
Installing and Wrapping Abrasives

7. Machine Operation

8. Maintenance

9. Troubleshooting

1. Declaration of Conformity

We declare that this product is in compliance with the directive and the standard mentioned on the previous page of this manual.

2. Warranty

The company IGM Tools & Machinery s.r.o. always strives to deliver a product of high quality and efficiency.

The application of the warranty is governed by the valid Business Conditions and the Warranty Conditions of the company IGM Tools & Machinery s.r.o.

3. Safety

3.1 Authorized Use

This machine is designed for sanding wood and wooden products only.

Sanding of other materials is not permitted but can be performed in specific cases only after consulting the manufacturer.

The machine is not suitable for wet sanding.

The required minimum age must be observed.

The machine must only be used in a technically perfect condition.

In addition to the operating instructions, also read the safety requirements and your country's applicable regulations.

You should observe the generally recognized technical rules and safety requirements concerning the operation of woodworking and metalworking machines.

Neither the manufacturer nor the supplier is liable for damage resulting from unauthorized use of the machine. Responsibility is transferred exclusively to the operator.

3.2 General Safety Notes

Woodworking machines can be dangerous if not used properly.

Read and understand the entire operating manual before attempting assembly or operation.

Protect this operating manual from dirt and humidity and pass it over to the

new owner if you part with the machine.

No changes to the machine may be made.

Daily inspect the function and existence of the safety appliances before you start the machine. Correct all defects or damaged safety appliances immediately. The machine must only be used in a technically perfect condition.

Protect long hair with a cap or hair net. Remove all loose clothing, rings, watches and other jewellery. Wear safety shoes; never wear leisure shoes or sandals. Follow personal protection guidelines.

Do not wear gloves while operating this machine!

Install the machine so that there is sufficient space for safe operation and workpiece handling.

The machine must be bolted on firm and levelled surface and must be properly lighted.

Always wear a protective mask in a dusty environment.

Keep work area well lighted.

Make sure the machine stands on a board.

Make sure that the power cord does not impede work. Keep work area clean. Never reach into the machine while it is operating or running down. Stay alert! Give your work undivided attention. Use common sense. Do not operate the machine under the influence of drugs, alcohol or any medication.

Keep children and visitors a safe distance from the work area. Never leave a running machine unattended. Before you leave the workplace switch off the machine.

Do not use the machine in a damp environment and do not expose it to rain.

Wood dust is explosive and can also represent a risk to health. In particular dust from tropical woods and hardwoods like beech and oak, is classified as a carcinogenic substance. Focus on the position of your fingers and other parts of your body when working.

Do not start the machine without safety appliances.

It is important to clamp all workpieces.

Machine only stock which rests securely on the table.

Do not remove chips and workpiece parts until the machine is at a standstill.

Minimum workpiece length is 60 mm.

Do not stand on the machine.

Repair work on the electrical installation may be carried out by a qualified electrician only.

Have a damaged or worn power cord replaced immediately.

Have a damaged abrasive replaced immediately.

3.3 Hazards

When using the machine according to regulations some remaining hazards may still exist.

Loose sanding belt can cause injury. The workpiece may bounce off the sanding belt and turn against the machine operator.

Danger of thrown workpiece.

Dust and noise can be health hazards.

Be sure to wear safety goggles, ear protection and dust mask.
Use a suitable dust exhaust system.
Defective or damaged sanding belt can cause injury.

Do not use damaged or worn power cord.

3.4 Grounding Instructions

Connection cord:

In the case of a defect or malfunction, grounding provides a path of least resistance to electric current, reducing the risk of electric shock. The machine is supplied with connection cord with a guard wire and euro plug. The plug must only be connected to an appropriate outlet in accordance with all local codes and regulations.

- Do not modify the plug, if it does not fit into the socket. Contact a qualified electrician and have the appropriate socket installed.
- Improper connection may result in a risk of electric shock. Ground wire is an insulated wire with a green surface with/without yellow stripes. If the cord or plug needs to be repaired, contact a qualified electrician.
- Damaged cords should be repaired immediately and only by a qualified electrician.
- Use only three-wire cables with a euro plug and an appropriate socket.

4. Machine Specification

Type: 1632

Power: 230 V / 50 Hz / 1 phase

Recommended circuit breaker: 16 A, rating C (16/1/C)

Current at maximum load: 6,5 A

Power output: 1100 W

Conveyor Belt Motor: 40 W

Speed: 1420 RPM

Feed Speed: 0-3 m/min.

Workpiece Width (one pass): 406 mm

Workpiece Width (two passes): 812 mm

Thickness of Material min. / max.: 0,8-76 mm

Drum Size: 127 x 406 mm

Width of Abrasive: 76 mm

Minimum dust collector capacities: 1000 m3/h

Dust Extraction Outlet: 100 mm

Length x width x height: 860 x 560 x 1220 mm

Weight: 62 kg

Shipping Dimensions: 940 x 660 x 550 mm

Shipping Weight: 71,7 kg

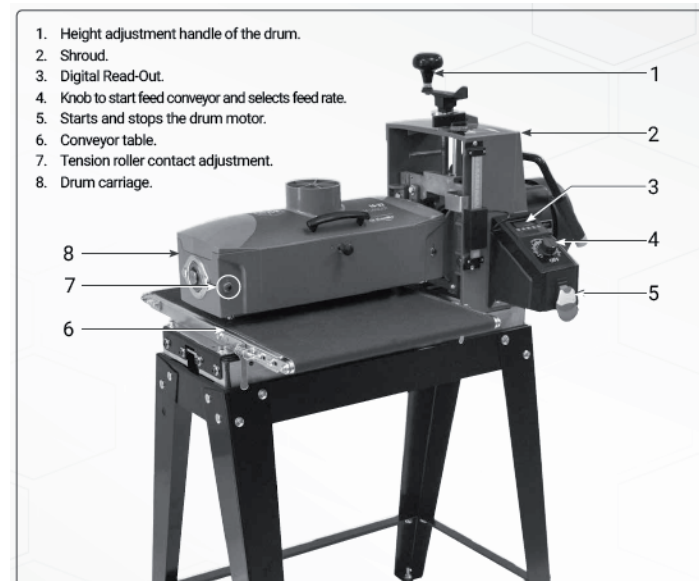

1. Height adjustment handle of the drum
2. Shroud
3. Digital Read-out
4. Knob to start feed conveyor and select feed rate
5. Starts and stops drum motor
6. Conveyor table
7. Tension roller contact adjustment

8. Drum carriage

5. Transport and Setup

5.1 Setup

The machine is transported in a shipping package. The machine is designed to operate in closed rooms and must be placed stable on a firm and levelled ground. The machine requires assembling.

Package contents

Stand box contents (found inside the main box)

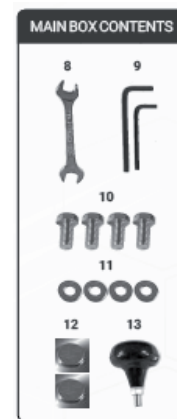

Drum Sander Assembly

Note: For initial stand assembly secure all bolts finger tight. This will allow for easier levelling after the sanding unit is installed on the stand. The holes in the legs are spaced so that the short and long top braces will only line up from one face of each leg.

1. Secure two legs to the outside of each of the two short top cross braces using the supplied carriage bolts and flange nuts.



2. Secure the two long top rails inside of the legs and on top of the short rails.



3. **Note:** Long rail on top of short rail and both rails inside of legs.



4. Connect the second leg sub-assembly to the top long rails.



5. Attach the lower cross braces to the legs. The longer cross braces should sit on top of the short ones.



6. Attach a levelling foot to the bottom of each leg (not required if installing optional caster set).

Note: After final assembly and sander installation, adjust the nuts on the threads as needed to level the stand.



Installing Drum Sander

1. For easier access to the machine, peel back the plastic liner, cut the box at the corners, and fold down the 4 sides of the box.

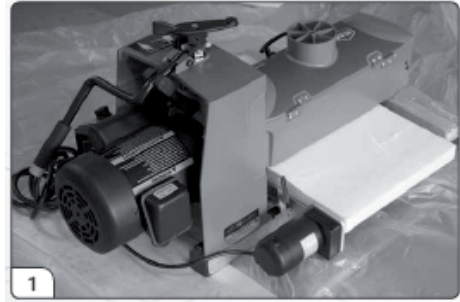

2. Then with the help of an assistant carefully lift the machine and set it down on a workbench with one end hanging slightly over the edge.

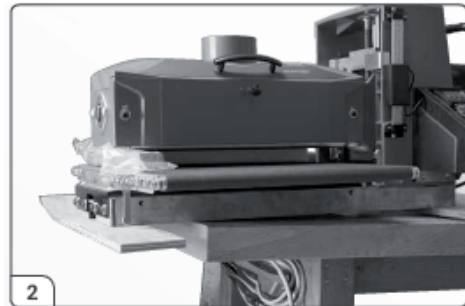

3. Unscrew the bolts holding the wooden packing support to the underside of the machine, then carefully turn the machine around and repeat at the opposite end (these bolts can be re-used to secure the unit to the stand; extra bolts are also provided for this with the machine).

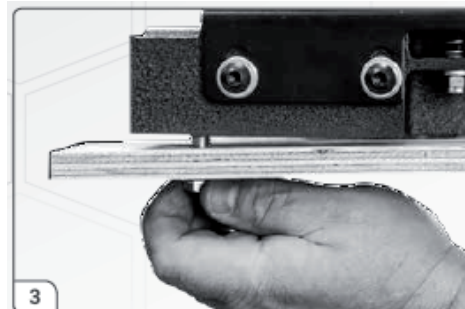

4. With the help of an assistant place the machine on the stand so that the mounting holes on the stand line up with the holes on the underside of the machine. Remove the Styrofoam and wooden support block from under the sanding head.

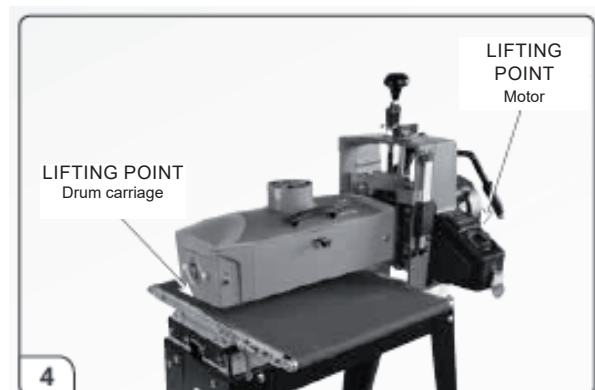

5. Using the supplied 14 mm wrench bolt the machine to the stand from underneath using the supplied hex bolts and washers.

Note: With the machine properly secured, level the stand and tighten all its bolts.

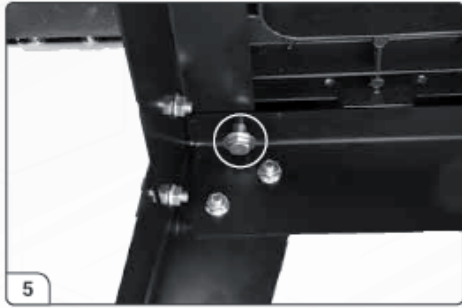

6. Screw the height adjustment knob into the handle and tighten it down.

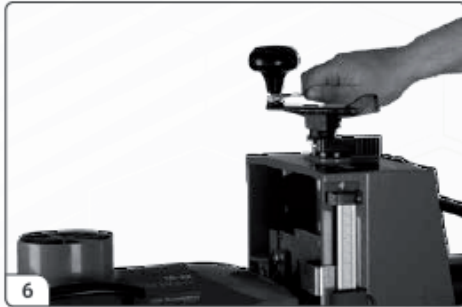

7.+ 8. Slide the digital read-out (DRO) out and install the supplied batteries with the (+) side facing up.

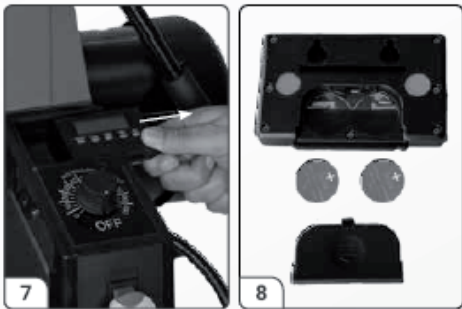

9. Slide the DRO fully back and plug in the cable from the machine.



Installing Drum Sander (continued)

10. Plug the short power cord that is attached to the motor into the outlet on the control panel.



11. Make sure that your power supply is adequate (230 V, circuit breaker

16 A, rating C (16/1/C)). Do not plug the machine into the power supply until it is fully setup.



6. Setting and Adjustment

6.1 Setting the Drum Sander

Checking Drum Alignment

UNPLUG THE MACHINE FROM THE POWER SOURCE!

During initial setup only. Checking the alignment is necessary to make sure that the machine functions properly.

1. Before checking the drum alignment make sure that the fast lever between the conveyor motor and the machine is in the up position. The conveyor table bolts on the inboard side should not be so tight that the fast lever does not rotate – see first note on page 17.

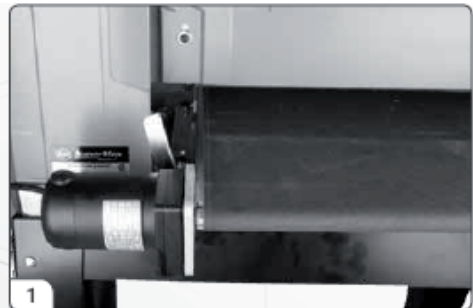

2. Remove abrasive from the drum. Removing the abrasive ensures that the adjustment is as accurate as possible.

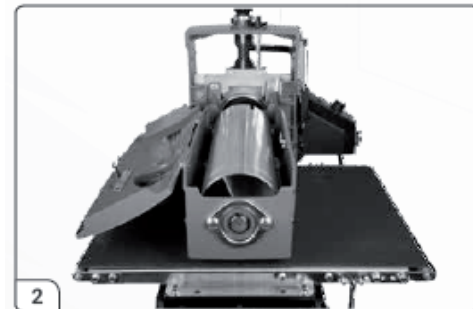

3. Use a flat, uniform piece of wood as a thickness gauge. Set it between the conveyor belt and the drum on the inboard (right) side of the machine.

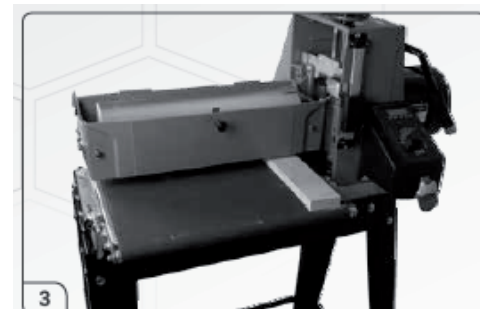

4. The tension rollers are set just below the drum enough so that material cannot pass easily underneath. Use the height adjustment handle to lower the head until the drum makes contact with the piece of wood. Turn on the DRO and take note of the thickness indicated on the display.

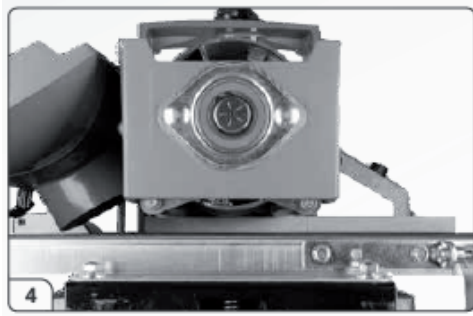

5. Raise the head of the sander by rotating the height adjustment handle up exactly one full turn.



6. After the height has been adjusted move the piece of wood over to the outboard side (left) and lower the head by turning the handle down exactly one full turn until the DRO thickness matches the noted thickness from step #4.

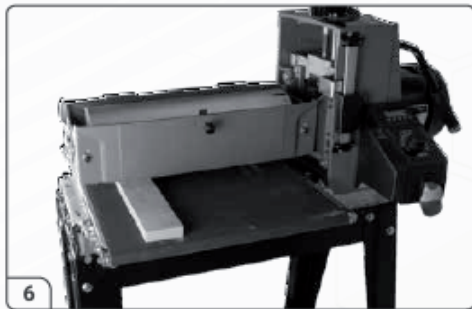

7. Check the height of the drum in relation to the piece of wood. If the drum is aligned it will just make contact with the wood as it did on the inboard side. If you cannot turn the handle one full turn, or if there is a gap between the drum and the wood, proceed to the following alignment procedure

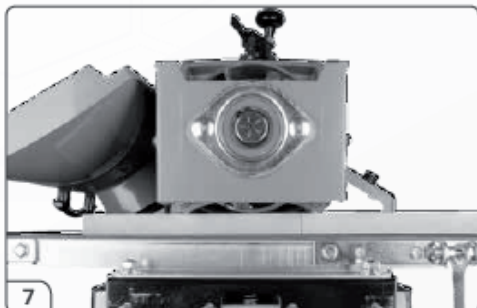

8. If the drum is not parallel, loosen the 4 socket head screws (A) along the outboard (left) side of the conveyor belt and raise or lower the conveyor with the adjustment nut (B) to achieve parallel alignment. Then tighten the 4 socket head screws.

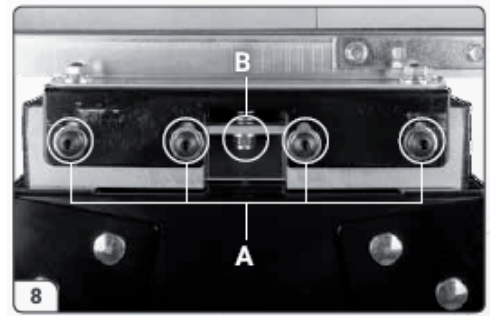

Connecting Dust Collection

Dust collection is necessary for the drum sander. The sander comes equipped with a 100 mm (4") diameter dust exhaust port at the top of the cover. Make sure that the minimum dust requirements are sufficient. To attach to your collection system, install 100 mm (4") hose from your collector. The minimum recommended dust collector capacities is 1000 m³/h. For best results, follow the recommendations of the manufacturer of your dust collector. When connecting dust collector straight pipe is preferred because it is the least restrictive for airflow. If straight pipe is not possible Y's and elbows are preferred because they are less restrictive to airflow than T's.

Note: Some applications will require more dust collection than the recommended minimum.

Power and Electrical Safety

11. Make sure that your power supply is adequate (230 V, circuit breaker 16 A, rating C (16/1/C))). After the dust collection system is in place and the drum alignment is checked your machine is ready to be powered up and operated.

Abrasive Selection Guide

To attach the abrasive to the drum, follow the procedure below.

Grit Common Application

- 36 GRIT - Abrasive planing, surfacing rough-sawn boards, maximum stock or glue removal
- 60 GRIT - Surfacing and dimensioning boards, truing warped boards
- 80 GRIT - Light dimensioning, removal of planer ripples
- 100 GRIT - Light surfacing, removal of planer ripples
- 120 GRIT - Light surfacing, minimal stock removal
- 150 GRIT - Finish sanding, minimal stock removal
- 180 - GRIT Finish sanding only, not for stock removal
- 220 GRIT - Finish sanding only, not for stock removal

6.2 Installing and Wrapping Abrasives

Accurate attachment of the abrasive to the drum is critical to achieving the machine top performance. Abrasive strips do not have to be pre-measured. The end of the roll is first tapered and attached to the outboard (left) side of the drum. Then the strip is wrapped around the drum. The second taper is made for attachment to the inboard (right) side of the drum.

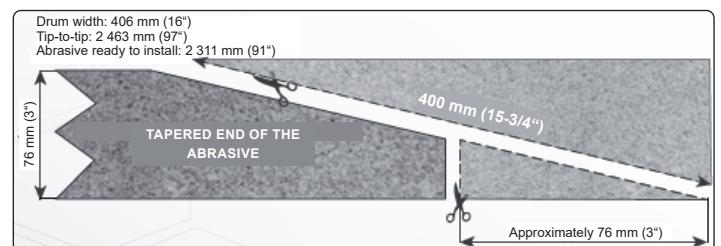

Note: Pre-cut abrasives have been factory tapered to the specific width of your drum. If you are cutting your own abrasive, use the wrap that came on the drum as a template (abrasive side up).

Installing and Wrapping Abrasives (continued) UNPLUG THE MACHINE FROM THE POWER SOURCE!

1. Start on the left (outboard) side of the drum. Squeeze the clip lever and insert the tapered end of the paper into the fastener so that it uses most of the width of the slot. Release the clip lever to securely hold the abrasive.

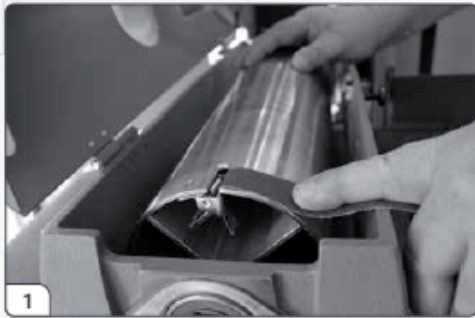

2. Wind the abrasive around the drum, being careful not to overlap the windings. The tapered cut of the wrap end should follow the edge of the drum. Continue to wrap the abrasive in a spiral fashion by rotating the drum with your left hand and guiding the abrasive with your right hand. Successive windings of the wrap should be flush with previous windings without any overlap.

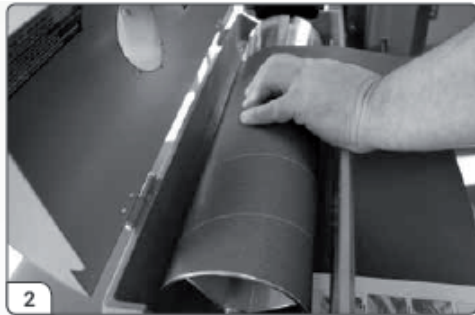

3. Squeeze the clip lever to open the clip and pull the take-up lever to the top. Insert the tapered end through the slot in the inboard (right) end of the drum.

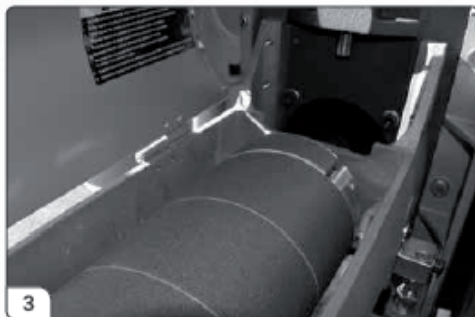

4. The take-up fastener is designed to automatically tension the abrasive wrap. If during use the abrasive wrap stretches enough to allow the take-up lever to reach its lowest position and no longer maintain tension on the wrap, see Abrasive Tension Adjustment.

Note: The drum was removed to show the inboard (right) take-up fastener.

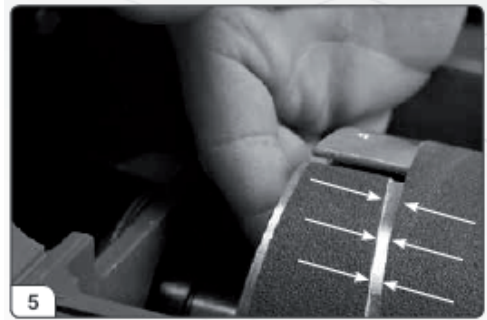
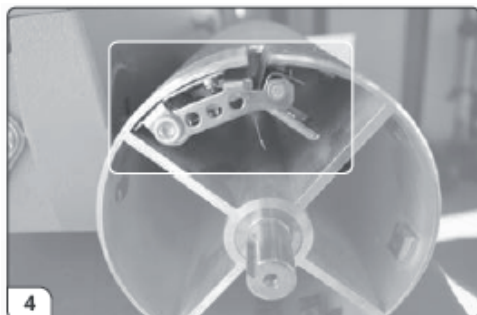

7. Machine Operation

Proper Abrasive Position

Position the abrasive in the slot with sufficient room between the inside of the slot and the tapered end of the wrap to allow it to be pulled into the drum as needed. If enough space is not left between the wrap and the inside of the slot the take-up fastener will not operate properly.

Abrasive Tension Adjustment

The abrasive wrap may stretch enough to allow the take-up lever to reach its lowest position. If this occurs, then the abrasive is no longer tensioned. To fix this reset the take-up lever by raising it. Push the abrasive into the slot and then release the clip lever.

Maximizing Abrasive Longevity

We recommend a sandpaper cleaning stick to remove deposits and help extend the life of the abrasive.

1. To use the cleaning stick, operate the sanding drum with the dust cover open and dust collection on.
2. Hold the cleaning stick against the rotating drum and move it along the drum surface.
3. Use a brush to remove any cleaning stick remnants before resuming operation.

ALWAYS WEAR EYE PROTECTION WHILE PERFORMING ABRASIVE CLEANING. TAKE ALL PRECAUTIONS TO AVOID ANY CONTACT WITH HANDS OR CLOTHING.

Operating the Sander

Using the DRO

Specifications

Resolution: Decimal = .005 in.
Fraction = 1/32 in.
Metric = 0.1 mm

Accuracy: Decimal = +/- .0025 in.
Fraction = +/- 1/500 in.
Metric = +/- .05 mm

Battery: 2 AAA (not included)

Functions:

- Constant memory retains calibration even when OFF
- Incremental measuring mode
- Absolute measuring mode
- Millimeter, Inch and Fraction readout
- Auto shut off



Button Reference and Use

It is helpful to familiarize these buttons and their purpose with the Wixey DRO

ON/OFF and CALIBRATION



- PUSH MOMENTARILY TO TURN OFF AND ON
- HOLD FOR 3-5 SECONDS TO ENTER CALIBRATION MODE. THE "ABS IN" FLASHES
- TO CHANGE THE DISPLAY VALUE FROM 0.000 USE THE + OR - BUTTONS.

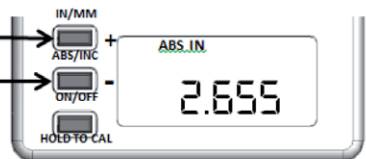

- A SHORT PRESS INCREASES ONE DIGIT. HOLDING THE BUTTON COUNTS FAST.
- PRESS THE ON/OFF BUTTON MOMENTARILY TO SET THE CALIBRATION VALUE. THE "ABS IN" WILL STOP FLASHING

IN/MM

Toggles between Inches and millimeters

Absolute measuring mode

Inch mode

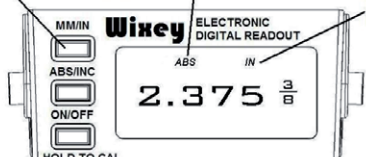

Millimeter mode

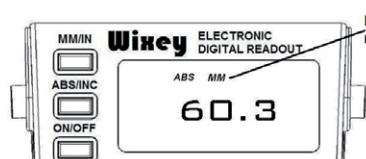

ABS/INC

Absolute measuring mode

Toggles between Absolute and Incremental modes

Incremental mode re-sets to 0.000

Toggle back to ABS mode and the dimension is remembered

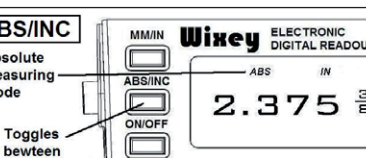
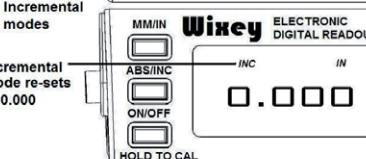
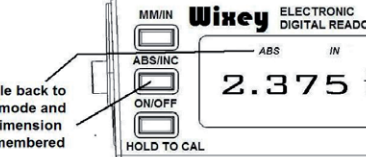
Calibration

There are three typical variations of calibration. The first variation (Type 1) is for the DRO to show the sanded thickness of the material. The second variation (Type 2) is to show how much stock is being removed with each pass of the sander. Another method (Type 3) to show the amount of material being removed per pass without recalibrating the Type 1 setting.

Type 1 Calibration ABS:

Calibration for the DRO to show sanded thickness (Type 1). Calibration is quick and easy and requires no extra measuring device. Make sure the machine is turned OFF and power is disconnected!

1. Wrap the sanding drum with the desired grit abrasive.
2. Lower the sanding drum until it lightly touches the conveyor belt.
3. Turn "ON" the DRO.
4. Hold the "CAL" button 3 seconds until "0.00" appears.



Type 2 Calibration ABS:

Calibration for the DRO to show stock removed per sanding pass (Type 2). Calibration is quick and easy and requires no extra measuring device. Make sure the machine is turned OFF and power is disconnected after the first step!

1. Sand a test piece of stock until it is flat and uniform on both sides.

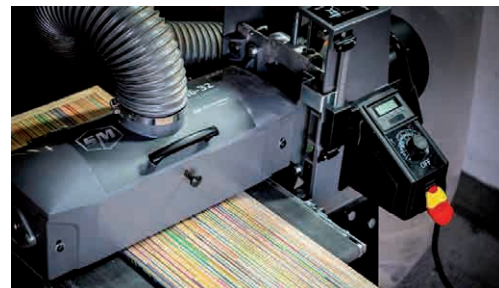

2. Turn the Sander OFF and disconnect power to sander.
3. Position the sanding drum (with abrasive still wrapped on drum) on the test piece until the drum is lightly touching the test piece.
4. Press and hold the "CAL" button for 3 seconds until "0.00" appears.



Type 3 Calibration INC:

This method allows saving the original calibration from Type 1 and confirming the amount of material being removed per pass.

1. Make one pass sanding your stock. Without changing the drum height press the "ABS/INC" button to read "0.00". This changes the readout from "ABS" to "INC" and zero's the readout on top of

the just sanded piece. Now the readout will show the amount of stock removed per sanded pass in "INC" mode.

2. To change back to the original (Type 1) calibration press the "ABS/INC" button to change back to "ABS" mode.

NOTE: When changing the abrasive wrap to a different grit the DRO must be recalibrated for the change of drum diameter with the new grit abrasive!

NOTE: When setting the depth of cut, never exceed the thickness of the grit for stock removal.

Depth of Cut/Sanding

Determining the depth of cut is the most important operating procedure decision. It may take some experimentation to determine the proper depth of cut. We recommend practicing on a scrap of wood prior to sanding a project.

TIP: With the sander turned OFF, place the stock to be sanded under the drum (wrapped with abrasive of choice) and lower the drum until the drum contacts the workpiece and the drum can be rotated with hand pressure. This is a good test for maximum stock removal as you are becoming familiar with setting the sander for proper stock removal.

Drum Head Height Adjustments

The drum height can be adjusted using one of two methods determined by the position of the height adjustment selector.

In the micro adjustment position turning the main height adjustment handle controls the height of the drum. Clockwise for Up and counter clockwise for Down.

Note: One full turn raises or lowers the head approximately 1,6 mm (1/16").

With the selector in the quick lever position the main handle is disengaged. Quick large-scale adjustments of up to 76,2 mm (3") can then be made by pulling up or down on the Quick Lever.

Note: After completing height adjustments in quick lever mode always return the selector back to micro adjustment mode.

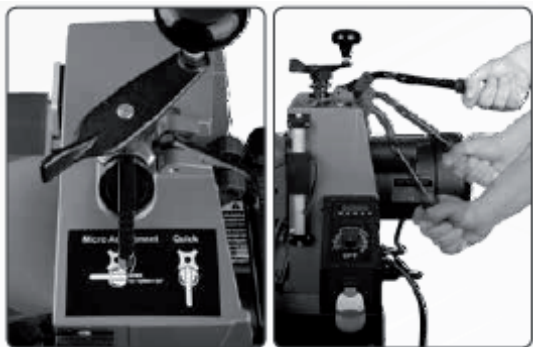
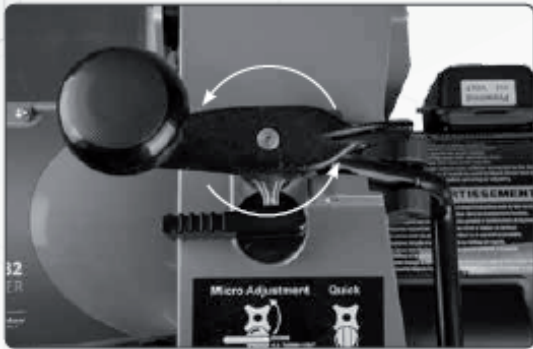

Conveyor and Speed Rate

After the depth of cut has been determined, selecting the proper feed rate is essential. For finish sanding the best finish is usually achieved with a slow to moderate feed rate. Faster feed rates can be used as long as the machine is not over-stressed.

When finish sanding with grits finer than 80, the best finish can usually be obtained if INTELLISAND does not engage. If INTELLISAND does slow the conveyor when finish sanding, it is best to make another sanding pass without changing the thickness setting and sand again

Note: INTELLISAND will automatically adjust the conveyor feed rate if an excess load is detected. This prevents excessive gouging, reduces the risk of burning and protects the machine from overload or stalling. The red light by the adjustment knob will come on when INTELLISAND is operating. When the load is decreased, INTELLISAND will automatically

increase the feed rate to the pre-selected speed.

Stock Feeding Operation

Rest and hold the stock to be sanded on the conveyor table. Allow the conveyor to carry the stock into the drum. Once the stock is halfway through, reposition yourself to the outfeed side of the machine to control the stock as it exits the unit.

Stock Feeding Maximum Performance

The versatility of this drum sander allows it to be used for a wide range of tasks. Learning to use the multiple controls to make adjustments will allow you to fine tune the machine for maximum results.

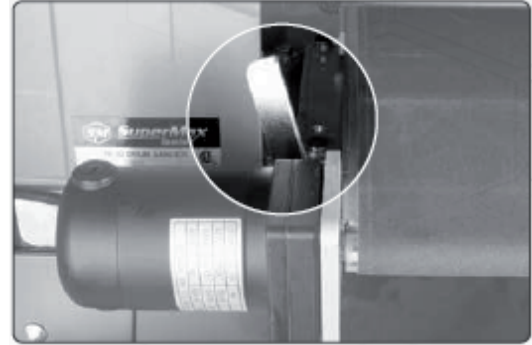

• Sanding stock wider than the drum

When sanding stock wider than the drum the fast lever will be very useful (see picture). Wide stock requires extra space between the drum and the conveyor on the outboard (left) edge. The extra space prevents ridge lines from developing along the part that extends beyond the drum. Adjust the fast lever 45 degrees from the vertical position to slightly shift the drum position. Before sanding always test on a scrap piece. If a line or ridge is still visible, make adjustments to the drum alignment. Always return the lever to the upright position when wide stock sanding is completed.

Note: The fast lever raises the inboard side of the table .003. Upon first use, the conveyor table bolts may be set too tight at the factory for secure shipping. In this case, loosen the bolts slightly. Never tighten the table bolts all the way. Tighten the bolts enough to still allow the fast lever to be moved.

• Sanding multiple pieces simultaneously

When sanding multiple pieces at once, make sure to stagger the pieces across the width of the conveyor belt. This position provides better contact with the tension rollers. It is best to only process pieces that are all of a similar thickness. If there is a thickness difference, the thinner pieces may not come in contact with the tension rollers and may slip on the conveyor belt.

• Sanding Imperfect or Tall Stock

To avoid bodily injury, take special care when sanding stock that is twisted, bowed or otherwise varied in thickness from end to end. If possible, support such stock as it is being sanded to keep it from slipping or tipping. Use extra roller stand, assistance from another person, or hand pressure on the stock to minimize potentially hazardous situations. Special attention is needed as the stock exits the machine. Special attention is needed as the stock exits the machine.

• Stock Feeding Position and Angle

Positioning the stock at an angle will allow the most effective stock removal and least loading on the abrasives. Feeding stock straight through yields the widest sanding capacity and least noticeable scratch pattern. Some pieces because of their dimensions will need to be fed into the sander at a 90-degree angle (perpendicular to the drum). However, even a slight offset angle of the stock can provide for more effective sanding. Final pass sanding should be done while following the grain pattern.

Tension Roller Pressure

The tension roller pressure is factory set and should be adequate. However, the pressure of each roller can be adjusted as needed. To increase the tension, turn the tension adjusting screw clockwise 1/4 revolution at a time. To decrease tension, turn the adjusting screw counter clockwise 1/4 revolution at a time.

Note: Too little pressure can result in slippage of stock on conveyor belt or kick-back. Too much tension can cause snipe when drum sanding.

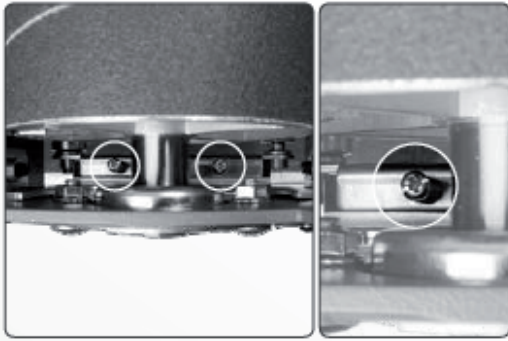

Tension Roller Contact Adjustment

The tension rollers are factory set for the most versatile use.

1. To adjust tension roller contact, loosen the four socket head screws holding the tension roller brackets (2 per side; front and back).
2. Have abrasive wrapped on the drum.
3. With the machine unplugged, lower sanding drum until it rests on conveyor belt.
4. Raise drum 2 to 3 revolutions.
5. Tighten the four socket head screws.
6. Raise the drum up, off of the conveyor belt.
7. Set the drum on the proper sanding height.

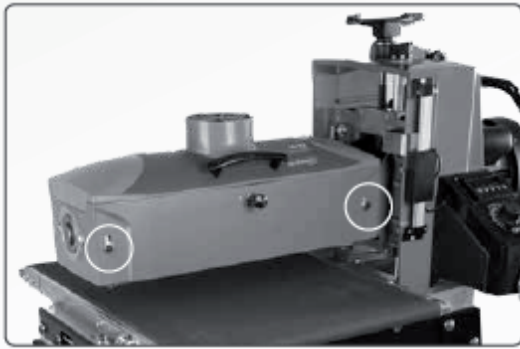

Conveyor Belt Tension

Insufficient belt tension will cause slippage of conveyor belt on the drive roller. The conveyor belt is too loose if it can be stopped by placing your hand directly on the conveyor belt. Excessive belt tension can result in bent rollers, premature wearing of the bronze bushings or conveyor belt.

To adjust the conveyor belt, first adjust the take-up screw nut on both sides of the conveyor to obtain approximately equal tension on both sides.

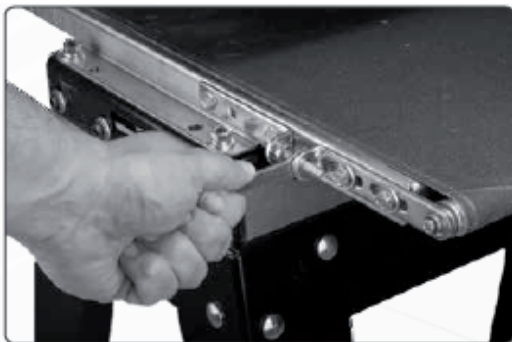

Conveyor Belt Tracking

Belt tracking adjustments are made while the conveyor belt is running. After the proper belt tension is obtained, turn the conveyor on and set it at the fastest speed setting. Watch for a tendency of the conveyor belt to drift to one side of the conveyor.

To adjust the belt tracking, tighten the take-up screw nut on the side the belt is drifting toward, and loosen the take-up screw nut on the opposite side.

Adjusting the take-up screw nuts does not affect the belt tension.

Note: Adjust the take-up screw nuts only 1/4 turn at a time. Allow the belt to react to the adjustments before proceeding further. Avoid over-adjustments.

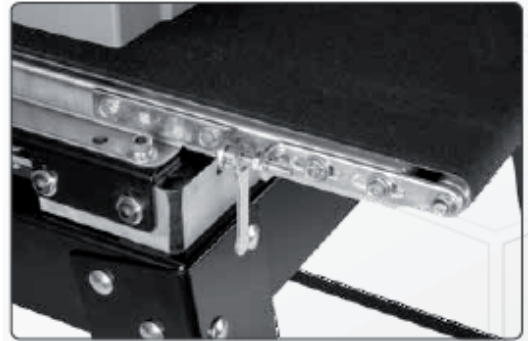

8. Maintenance

Monthly Maintenance

- Lubricate conveyor bushings and check for wear.
- Lubricate with a dry lubricant spray all of the moving parts.
- Clean dust from conveyor belt.
- Check all set screws for tightness.
- Clean drum and abrasives if necessary.

Replacing Conveyor Belt

To replace the conveyor belt, the conveyor assembly must be removed from the machine.

Unplug the machine from the power source!

1. Raise the drum carriage to its highest position. Unplug main drive motor from receptacle on the machine.



2. Loosen the conveyor take-up screws to relieve belt tension and slide the drive roller fully inward.



3. Remove the two hex bolts on the inboard (right) side that attach the conveyor assembly to the base.



4. Remove the two nuts and washers from outboard (left) side. Lift the conveyor and remove it from the sander. Set conveyor on motor side. Avoid tearing the belt on any edges underneath the conveyor bed during removal. Reverse the procedure for re-installation.

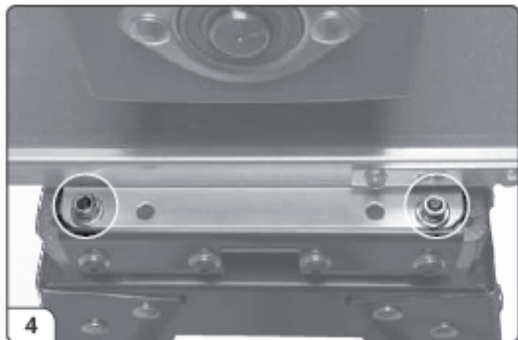

Cleaning the Sander

The sander may need to be cleaned more frequently depending upon frequency of use. The drum and the conveyor belt need to be clean. Allowing excess build-up of dust and debris can adversely affect performance and increase the likelihood of slippage on the conveyor belt. Sweep the conveyor belt clean after all operations. When cleaning dust from the drum leave the dust collection system on.

Optional Accessories:

IGM Fachmann Stick Abrasive Cleaner
Order code: MCBP

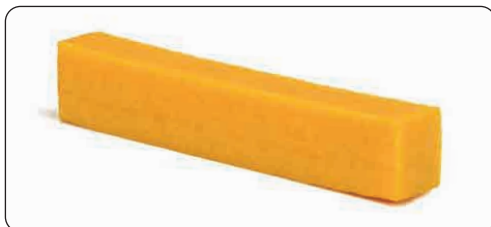

IGM LAGUNA 1632 Drum Sander Folding Infeed/Outfeed Tables
Order code: 151-1632FT

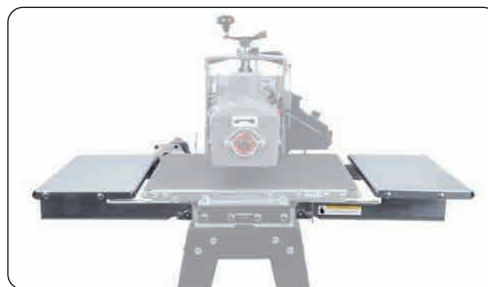

Conveyor Belt

IGM LAGUNA Conveyor Belt for Sander 1632 SuperMax
Order code: 151-1632-015



Abrasives

Up to date offer at www.igmttools.com

9. Troubleshooting

Any operating problems will likely occur during the period of becoming familiar with the sander. If you are experiencing a problem affecting the machine's performance, check the following listings for potential causes and solutions. Also review the previous sections in this manual on setting up and operating your machine.

TROUBLESHOOTING GUIDE: MOTOR

Problem	Possible Cause	Solution
Motor does not start	Main power cord unplugged from receptacle	Plug in primary power cord
	Drum motor cord unplugged from receptacle near powerfeed motor	Plug in drum motor cord to receptacle on the machine
	Circuit fuse blown or circuit breaker tripped	Replace fuse or retrip breaker (after determining cause)
Brush motor overloads	Inadequate circuit	Check electrical requirements
	Machine overloaded	Use slower feed rate; reduce depth of cut
Conveyor motor oscillates	Motor not properly aligned	Loosen housing bolts and hex screw holding the coupler to drive roller
	Shaft collar or bushing worn	Replace shaft collar or bushing
	Drive roller bent	Replace drive roller
Drum motor or Conveyor gear motor stalls	Excessive depth of cut	Reduce depth of cut; reduce feed rate

TROUBLESHOOTING GUIDE: CONVEYOR

Problem	Possible Cause	Solution
Conveyor drive rollers run intermittently	Shaft coupling loose	Align shaft flats of gear motor and drive roller; tighten shaft coupling set screws
Conveyor belt slips on drive roller	Improper conveyor belt tension	Adjust belt tension
	Excessive depth of cut	Reduce depth of cut; reduce feed rate
Stock slips on conveyor belt causing gouging	Excessive depth of cut Reduce depth of cut	Tension rollers too high Lower tension rollers
	Excessive feed rate	Reduce feed rate
	Dirty or worn conveyor belt	Clean or replace conveyor belt
Conveyor motor stalls	Belt out of adjustment	Readjust belt
	Roller bushings elongated due to excessive wear	Replace bushings

TROUBLESHOOTING GUIDE: MACHINE

Problem	Possible Cause	Solution
Drum height adjustment works improperly	Improper adjustment of height control	Readjust height control
Knocking sound while running	Bearing worn	Replace the bearing. Contact distributor
Sniping of wood (gouging near end of board)	Inadequate support of stock	Use roller stands to support stock
	Conveyor drive or driven rollers higher than conveyor bed	Readjust rollers
	Excessive tension roller pressure	Adjust rollers
Burning of wood or melting of finish	Feed rate too slow	Increase feed rate
	Excessive depth of cut	Reduce depth of cut
Conveyor motor stalls	Conveyor belt is too loose	Adjust belt tension
	Excessive depth of cut	Reduce depth of cut
	Wood slipping on conveyor due to lack of contact	Use alternate feeding procedure

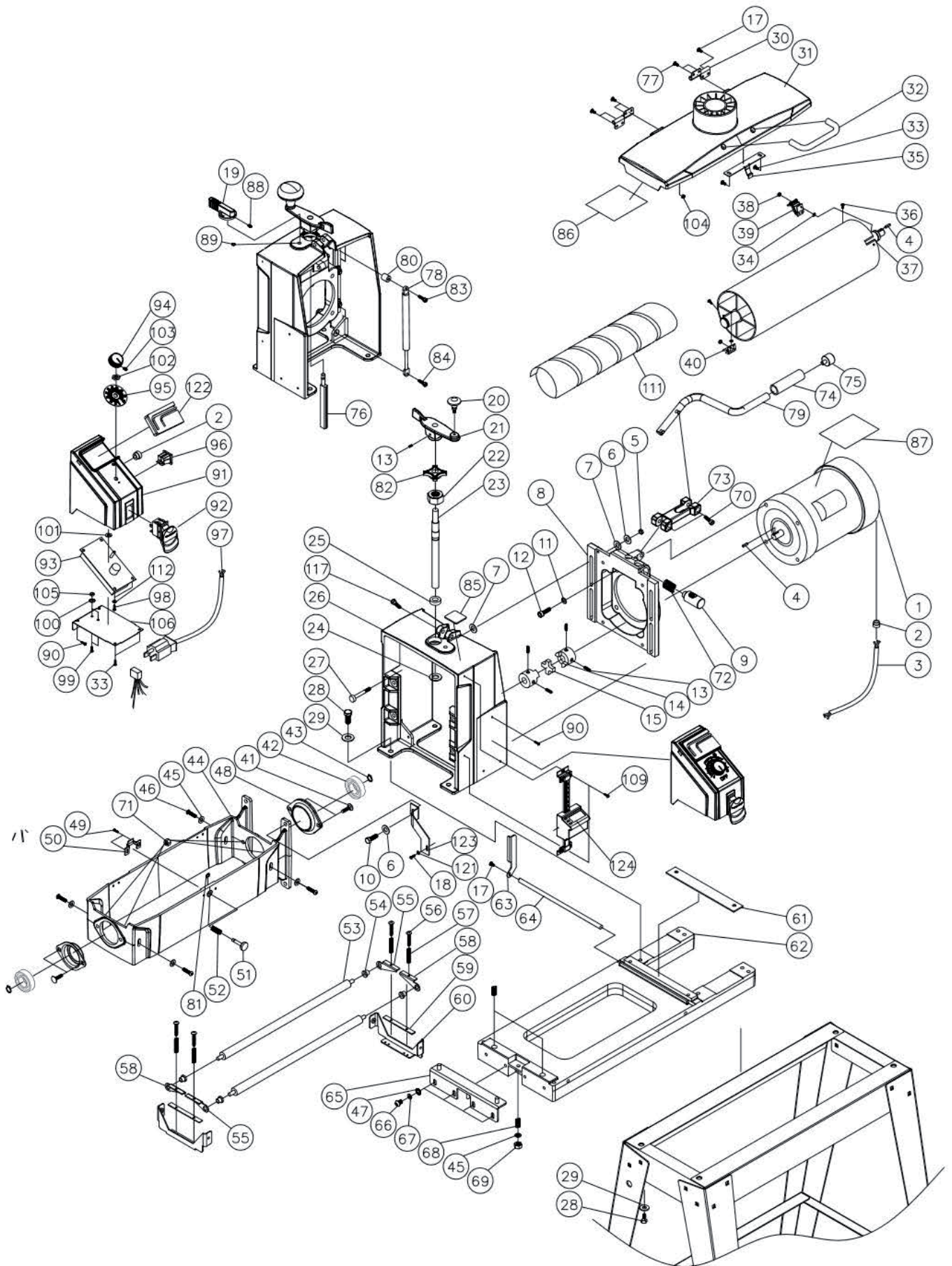

#	PART NO	DESCRIPTION	SIZE	QTY
Key	Part Number	Description	Specification	Qty
1	71632-101	Motor		1
2	480BS-102	Strain Relief, motor	7P-2	3
3	71632-103	Main Cord, Inverter to Control Box		1
4	480BS-104	Key	3/16"SQx3/4"	2
5	480BS-105	Nylon Insert Lock Nut	5/16"-24	4
6	480BS-106	Flat Washer	5/16"	8
7	480BS-107	Oilite Washer	5/16"	8
8	71632-108	Motor Plate		1
9	71632-109	Nut		1
10	71632-110	Hex Cap Screw	5/16"-18x1"	4
11	480BS-111	Lock Washer	3/8"	4
12	71632-112	Socket Head Cap Screw	3/8"-16x3/4"	4
13	480BS-113	Set Screw	1/4"-20x1/4"	5
14	480BS-114	Coupling		2
15	480BS-115	Coupling Spider		1
17	480BS-117	Screw, Phil Pan Head	M4x0.7x6	5
18	71632-118	Screw	M3x0.5x8	1
19	71632-119	Micro Adjustment/Quick Knob		1
20	480BS-120	Knob		1
21	480BS-121	Height Adjustment Handle		1
22	480BS-122	Nylon Insert Lock Nut	5/8"-11	1
23	71632-123	Height Adjustment Screw		1
24	71632-124	Washer, Wave	D17	1
25	480BS-125	Thrust Bearing	51103	1
26	71632-126	Shroud		1
27	30-3028	Stud		4
28	71632-128	Hex Cap Screw	3/8"-16x3/4"	8
29	480BS-129	Flat Washer	3/8"	8
30	480BS-130	Hinge		2
31	71632-131	Dust Cover		1
32	480BS-132	Handle		1
33	480BS-133	Pan Head Machine Screw	#8x1/2"	4
34	480DS-134	Lock Washer	M3	2
35	480BS-135	Dust Cover Latch		1
36	480DS-136	Phillips Flat Head Screw	M3x0.5x10	2
37	71632-137	Sanding Drum		1
38	480DS-138	Hex Nut	M3x0.5	2
39	480DS-139	Inboard Abrasive Fastener		1
40	480DS-140	Outboard Abrasive Fastener		1
41	71632-141	Carriage Bolt	5/16"-18x3/4"	4
42	480DS-142	Bearing	6205LLU	2
43	480DS-143	C-Ring	S25	2
44	71632-144	Drum Carriage		1
45	480BS-145	Flat Washer	1/4"	5
46	71632-146	Round Socket Head Cap Screw	1/4"-20x3/4"	4
47	480BS-147	Flat Washer	5/16"	4
48	480DS-148	Bearing Seat		2
49	480BS-149	Hex Cap Screw w/ Washer	#10-24x3/8"	2
50	480BS-150	Dust Cover Catch		1
51	480BS-151	Stud		1
52	480BS-152	Spring		1
53	71632-153	Tension Roller		2
54	480BS-154	Bushing, Oilite		4
55	480BS-180	Tension Roller Bracket, Outer Left		2
56	480BS-156	Screw	5/32"-32x1"	4
57	480BS-157	Spring, Tension Roller		4
58	480BS-179	Tension Roller Bracket, Outer Right		2
59	480BS-159	Pad, Bracket-Tension Roller		2
60	71632-160	Bracket		2
61	480BS-161	Plate		1
62	71632-162	Base		1
63	480BS-163	Adjusting Lever (FAST)		1
64	480BS-164	Adjusting Rod		1
65	480BS-165	Height Adjusting Plate		1
66	71632-166	Round Socket Head Cap Screw	5/16"-18x3/4"	4
67	480BS-167	Lock Washer	5/16"	4
68	480BS-168	Spring		3
69	480BS-169	Nylon Insert Lock Nut	1/4"-20	1
70	71632-170	Socket Head Cap Screw	5/16"-18x1-1/2"	2
71	480DS-171	Hex Nut w/ Washer	5/16"	4
72	71632-172	Spring		1
73	71632-173	Quick Arm		1
74	71632-174	Rubber Sleeve		1
75	71632-175	Cap		1
76	71632-176	Micro Adjustment/Quick Bar		1
77	71632-177	Screw, Phil Pan Head	M4x0.7x10	4
78	71632-178	Cylinder		1
79	71632-179	Quick Arm Handle		1
80	71632-180	Spacer		1
81	480BS-181	E-Ring	E5	1
82	71632-182	Nut		1
83	71632-183	Socket Head Cap Screw	M6x1.0x30	1
84	71632-184	Socket Head Cap Screw	M6x1.0x15	1
85	71632-185	Micro Adjustment/Quick Label		1
86	480BS-186	Maintenance Label		1
87	480BS-187	Warning Label		1
88	71632-188	Set Screw	1/4"-20x3/8"	1

#	PART NO	DESCRIPTION	SIZE	QTY
89	71632-189	O-Ring	P8	1
90	71632-190	Screw	M5x0.8x12	3
91	71632-191	Cover, Base-Control Box		1
92	71632-192	Switch, ON/OFF		1
93	480DS-210	Controller		1
94	480BS-207	Knob		1
95	71632-195	Speed Adjustment Label		1
96	480DS-213	Receptacle, Main Cord		1
97	480DS-203	Power Cord		1
98	71632-198	Pan Head Self-Tapping Screw	M3x0.5x10	2
99	480BS-214	Screw	#10-32x1/2"	2
100	480BS-215	Washer, Lock-Int. Tooth	#10	2
101	480BS-204	Flat Washer	5/16"	1
102	480BS-242	Hex Nut	5/16"-24	1
103	480BS-243	Slotted Set Screw	#8-36x5/16"	1
104	71632-1104	Hex Nut	M4x0.7	4
105	71632-1105	Hex Nut	#10-32	2
106	71632-1106	Cover, Base-Control Housing		1
109	72550-197	Screw, Phil Pan Head	M4x0.7x12	2
111	71632-1111	Abrasive	#80	1
112	71632-1112	Nylon Washer	M3	2
117	71632-1117	Socket Head Cap Screw	5/16"-18x1-3/4"	1
121	71632-1121	Flat Washer	M3	1
122	71632-1122	Tool Storage		1
123	71632-1123	Fixed Plate, DRO		1
124	71632-1124	Wixey Digital Readout (AAA Batteries not included)	1	

16-32 - WIRING DIAGRAM

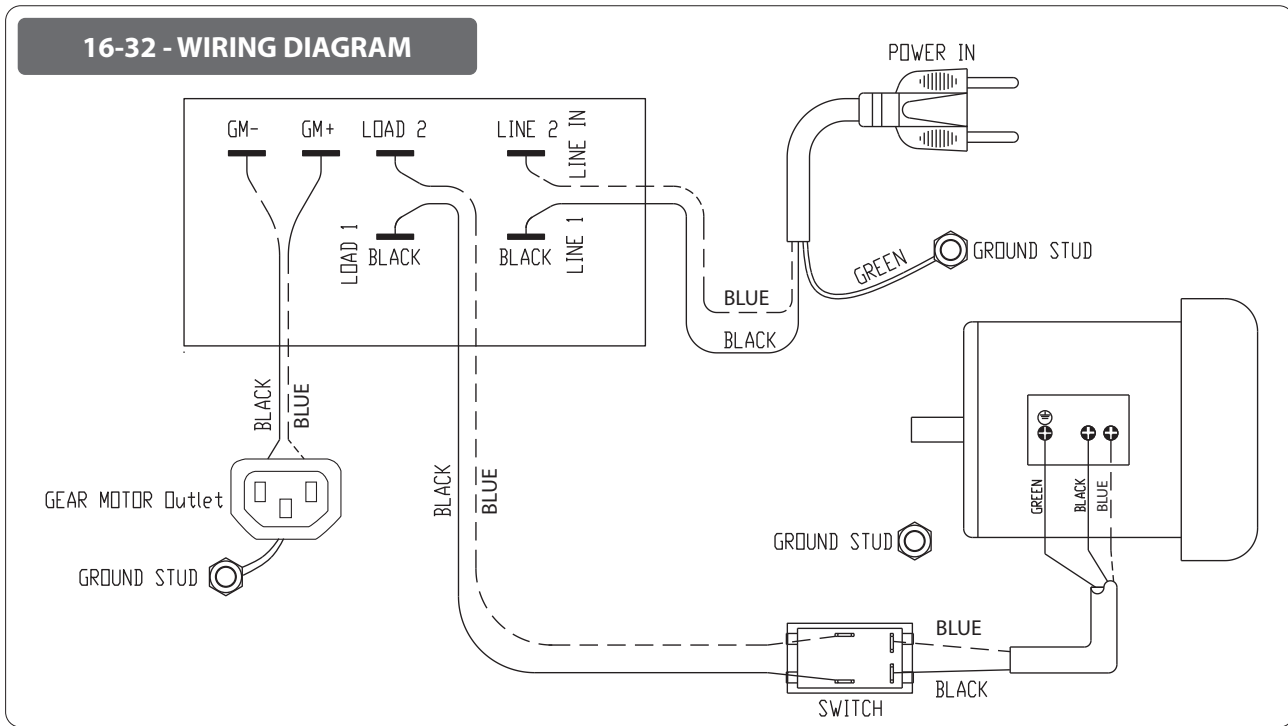

16-32 - OPEN STAND ASSEMBLY

#	PART NO	DESCRIPTION	SIZE	QTY
1	480BS-501	LEG, LEFT		2
2	480BS-502	LEG, RIGHT (WITH TOOL HOLDER)		2
3	71632-303	TOP CROSS BRACE, LONG		2
4	71632-304	TOP CROSS BRACE, SHORT		2
5	71632-305	LOWER CROSS BRACE RAIL, LONG		2
6	71632-306	LOWER CROSS BRACE RAIL, SHORT		2
7	480BS-507	FLANGE NUT	5/16"	8
8	480BS-508	LEVELING FOOT		4
9	480BS-129	FLAT WASHER	3/8"	8
10	480BS-509	HEX NUT	3/8"-16	8
11	480BS-506	CARRIAGE BOLT	5/16"-18 X 5/8"	24

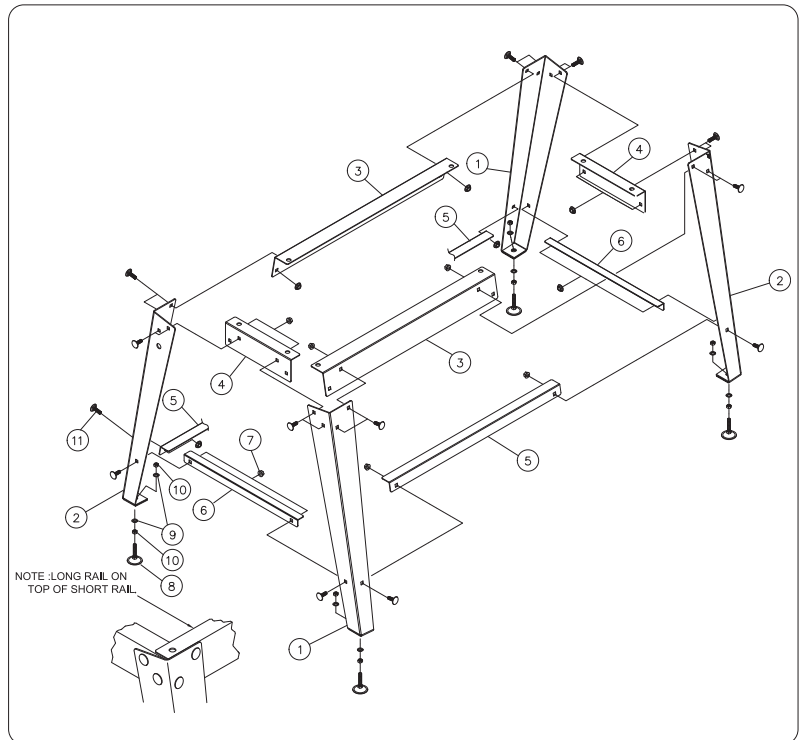



IGM nástroje a stroje s.r.o., Ke Kopanině 560,
Tuchoměřice, 252 67, Czech Republic, EU
+420 220 950 910, www.igmtools.com